

TRENCH MOS RECTIFIERS

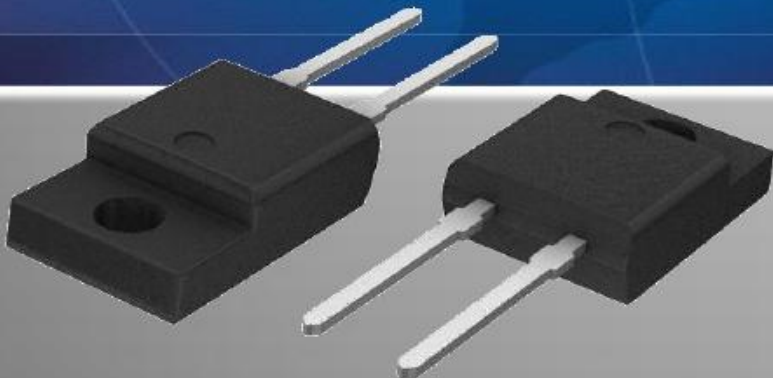

Contents

- **Product Part Number**
- **Product Feature**
- **Product Performance**
- **Product Line**
- **Applications**

Product Part Number

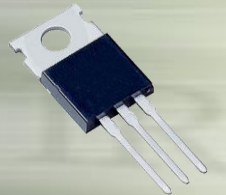

TO-220AB



ITO-220AB

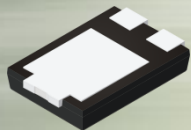

TO-277

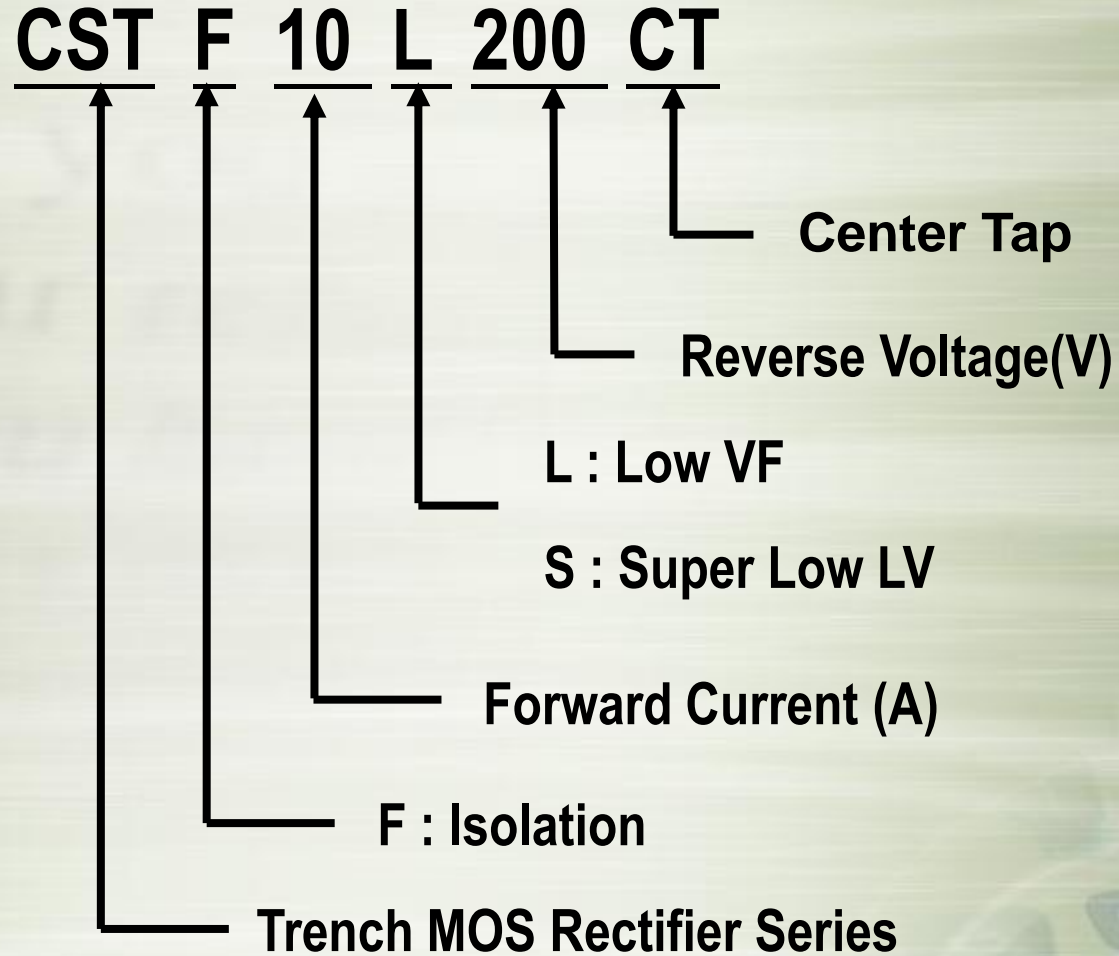

Product Feature

- **Low Forward Voltage(VF) / Low Reverse Current(IR)**
- **Fast switching capability**
- **Excellent high temperature stability**
- **Excellent High temperature performance**
- **Low power losses**
- **High efficiency operation**

	Forward Voltage, V_F	Leakage Current, I_R	Junction Temperature, T_j	Reverse Recovery Time, t_{rr}	Efficiency	High temperature stability
PN Junction Rectifiers	X Poor	✓ Very Good	✓ Very Good	X Poor	X Poor	Good
Schottky Diodes	Good	X Poor	X Poor	✓ Very Good	Good	X Ordinary
MOS Rectifier	✓ Very Good	✓ Very Good	✓ Very Good	✓ Very Good	Good	Good
Trench MOS Rectifier	✓ Very Good	✓ Very Good	✓ Very Good	✓ Very Good	✓ Very Good	✓ Very Good

Specification comparison

Trench MOS Rectifier-CST20L40CT

Forward Voltage (VF)

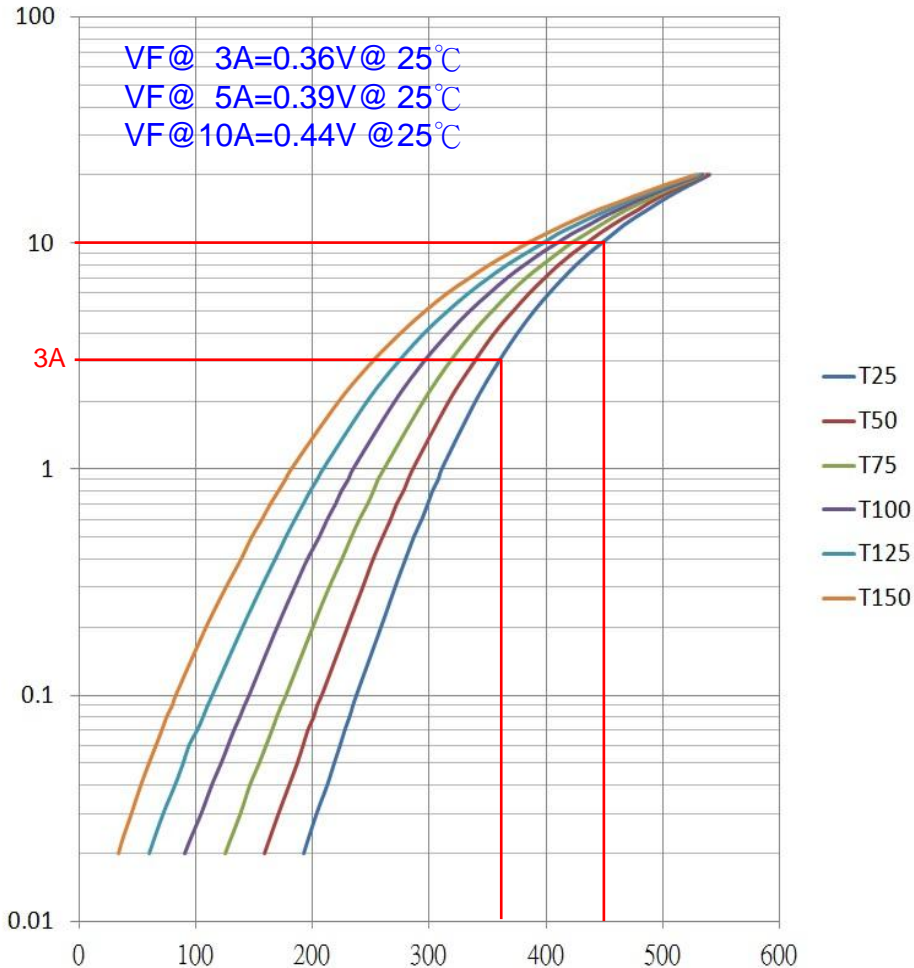

25度-Forward Voltage

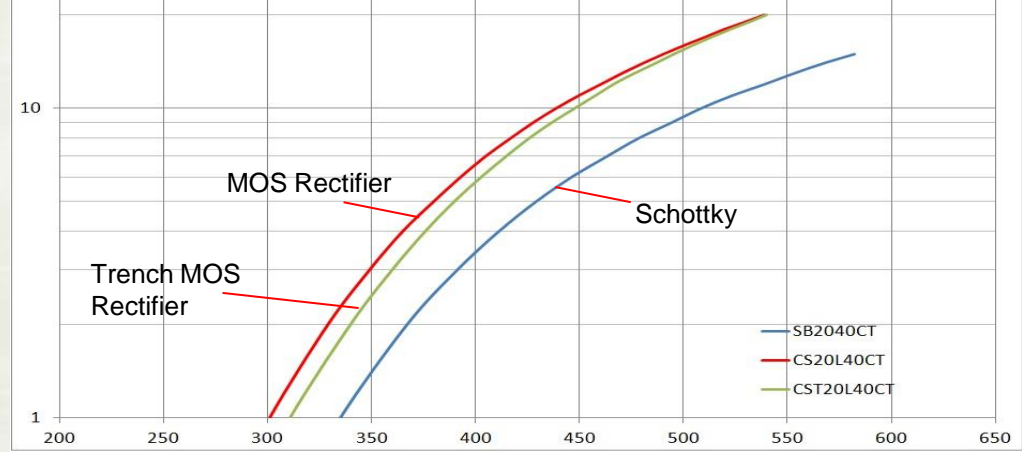

125度 Forward Voltage

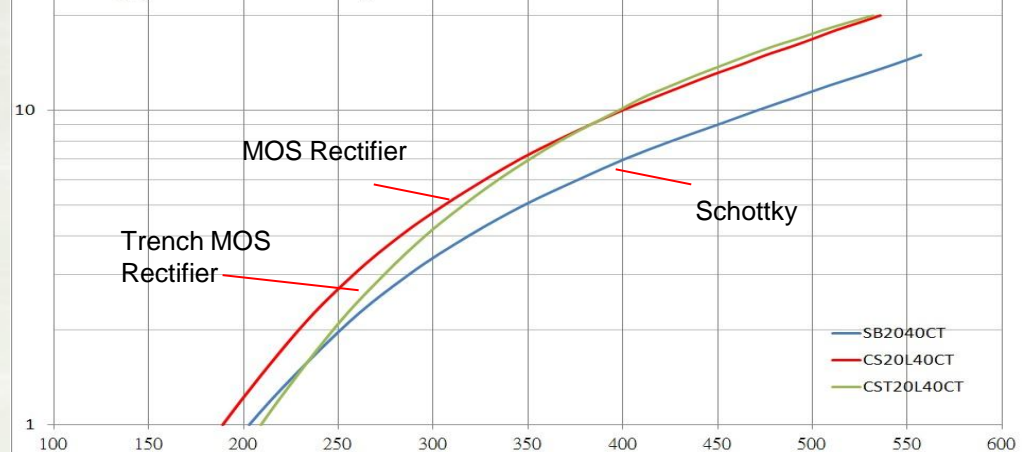

Specification comparison

Trench MOS Rectifier-CST20L40CT

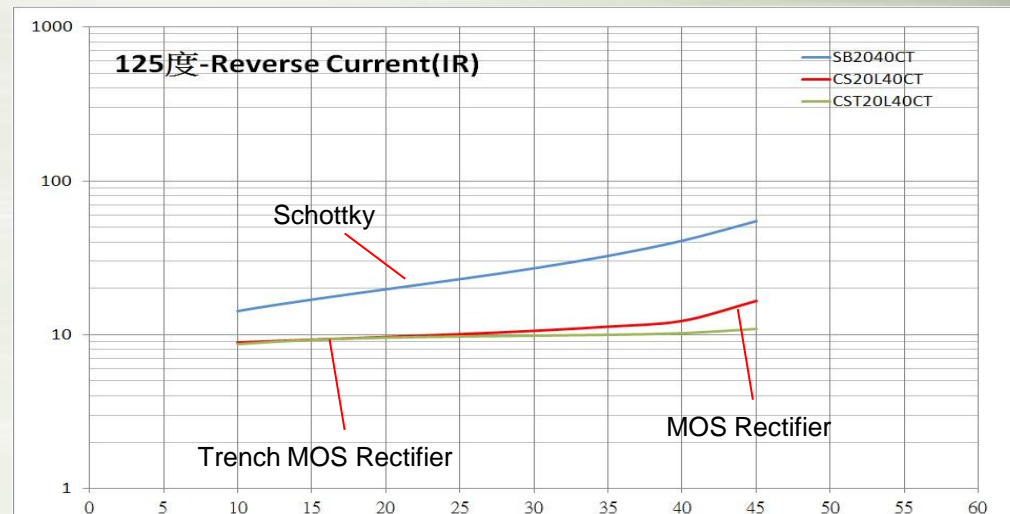
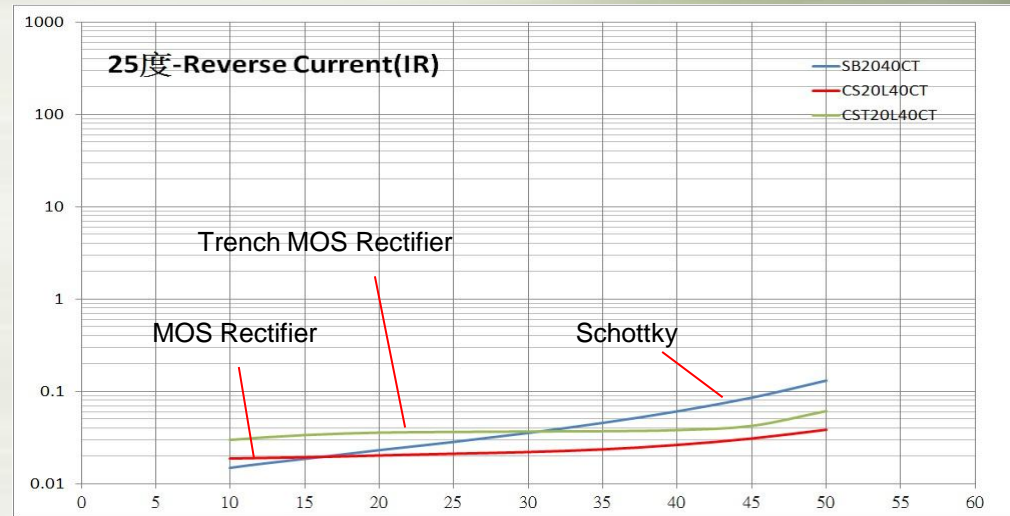
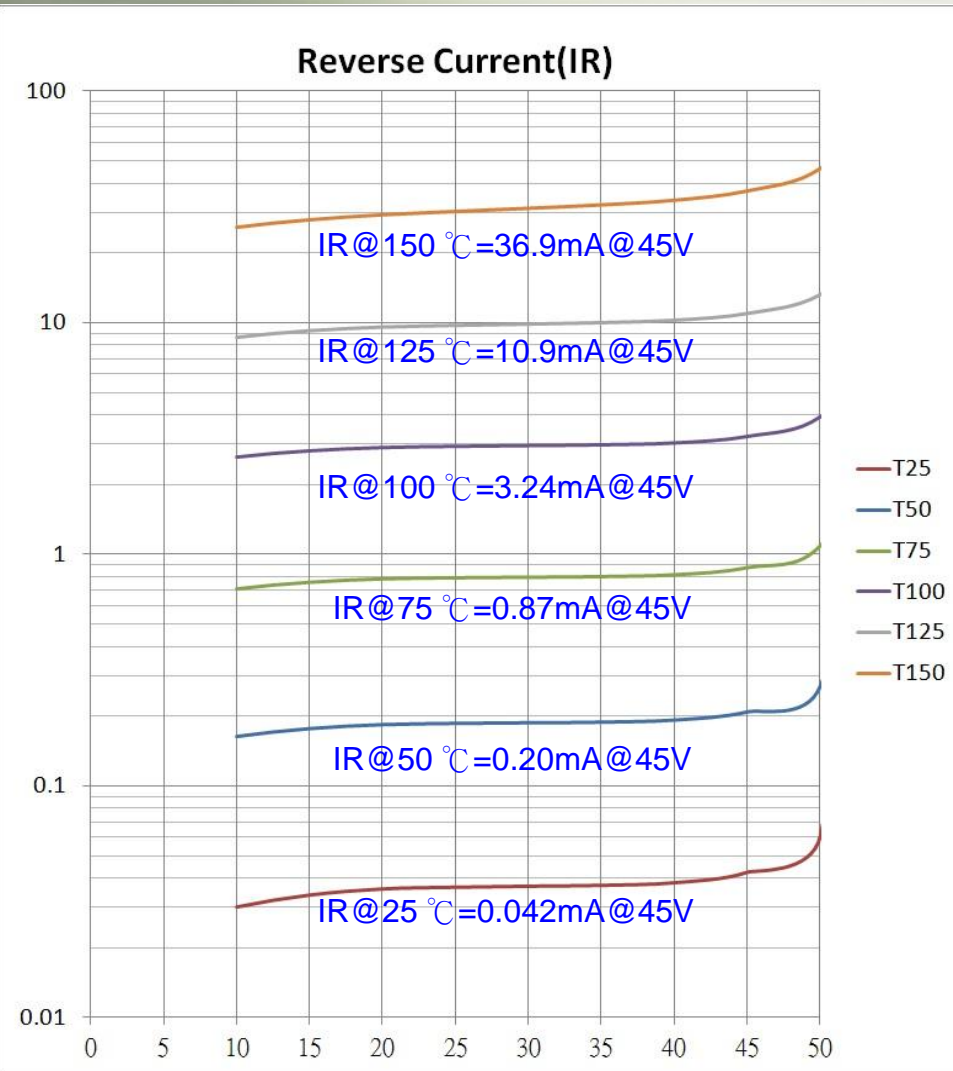

Specification comparison

Product	AC voltage	I (out)	Power (in)	Power (out)	Efficiency (%)	Temperature (C)
SB2045CT (Planar SKY)	220V	2.5A	16.1W	12.63W	78.4	97.5C
CS20L45CT (MOS LVF)	220V	2.5A	15.74W	12.63W	80.2	93.2C
CST20L40CT (Trench MOS LVF)	220V	2.5A	15.4W	12.63W	82.0	88C

Applications

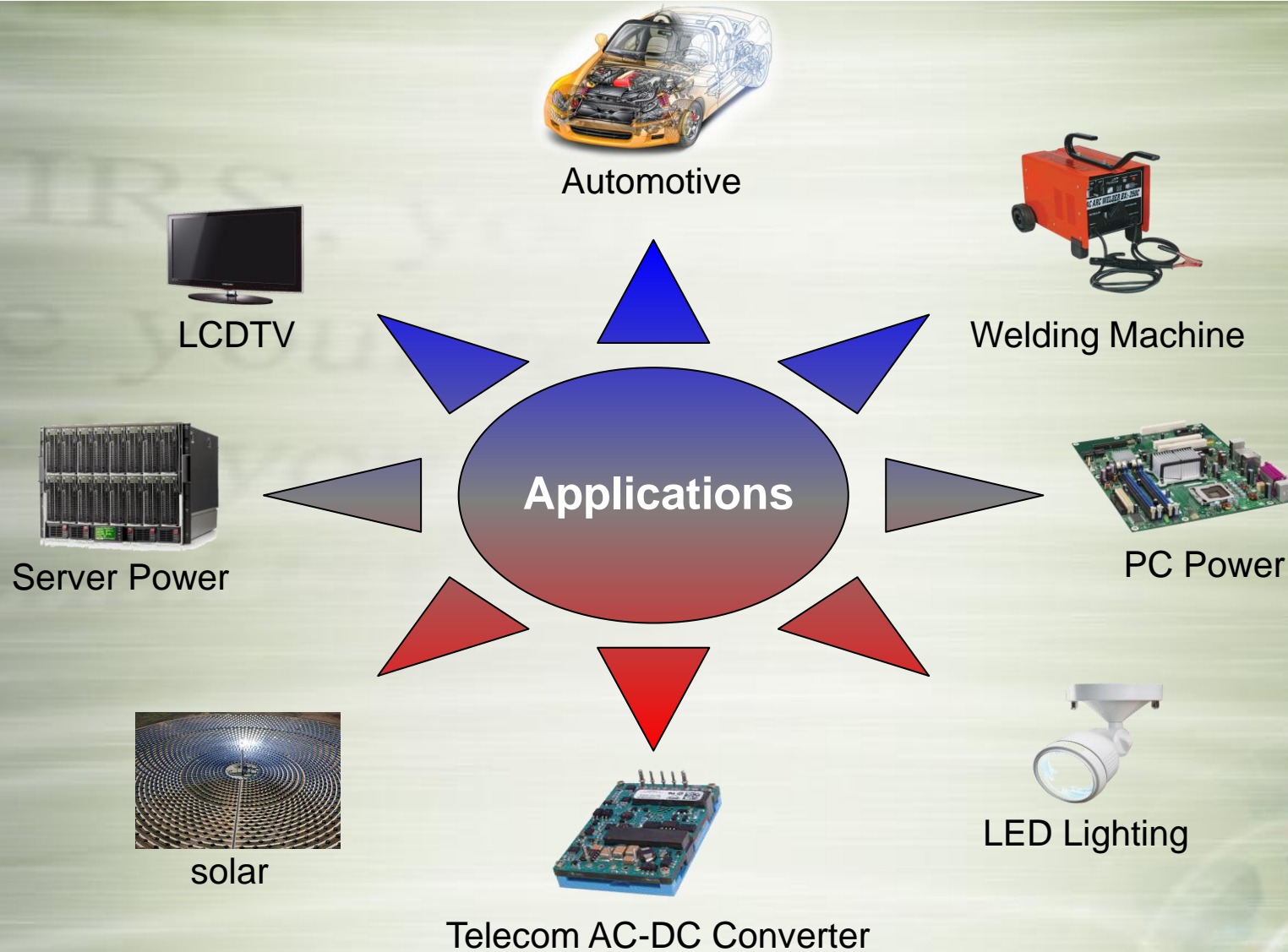

Trench MOS Rectifier Target Item

V \ A	8A (TO-277)	10A (TO-277)	12A (TO-277)	15A (TO-277)
45V		V		V
60V				
80V				
100V	V	V	V	
120V	V	V	V	
150V				
200V				

V \ A	10A TO/ ITO-220AB	20A TO/ ITO-220AB	30A TO/ ITO-220AB	40A TO/ ITO-220AB
45V	V	V	V	V
60V	V	V	V	V
80V				
100V	V	V	V	V
120V	V	V	V	
150V				
170V				
200V				

THANK YOU